

HD-Ready Widescreen LCD TV with Digital Tuner





This product contains electrical or electronic materials. The presence of these materials may, if not disposed of properly, have potential adverse effects on the environment and human health. Presence of this label on the product means it should not be disposed of as unsorted waste and must be collected separately. As a consumer, you are responsible for ensuring that this product is disposed of properly. To find out how to properly dispose of this product, please go to www.polaroid.com and click on "Company" or call the customer service number for your country listed in the instruction manual.

HDMI™

This TV incorporates High-Definition Multimedia Interface (HDMI™) technology. HDMI, the HDMI logo and High-Definition Multimedia Interface are trademarks or registered trademarks of HDMI Licensing LLC.

Federal Communications Commission Statement



ENGLISH

This equipment has been tested and found to comply with the limits of a class B digital device, pursuant to Part 15 of the FCC Rules. These limits are designed to provide reasonable protection against harmful interference in a residential installation. This equipment generates, uses and can radiate radio frequency energy and, if not installed and used in accordance with the instructions, may cause harmful interference to radio communications. However, there is no guarantee that interference will not occur in a particular installation. If this equipment does cause harmful interference to radio or television reception, which can be determined by turning the equipment off and on, the user is encouraged to try to correct the interference by one or more of the following measures:

1. Reorient/Relocate the receiving antenna.
2. Increase the separation between the equipment and receiver.
3. Connect the equipment into an outlet on a circuit which is different from what the receiver is connected to.
4. Consult the dealer or an experienced radio/TV technician for help.



Changes or modifications not expressly approved by the manufacturer responsible for compliance could void the user authority to operate the equipment.

Warnings and Precautions

To prevent any injuries, the following safety precautions should be observed in the installation, use, servicing and maintenance of this equipment.
 Before operating this equipment, please read this manual completely, and keep it nearby for future reference.



WARNING

This symbol is intended to alert the user to avoid the risk of electric shock.
 This equipment must not be disassembled by anyone except qualified service personnel.



CAUTION

This symbol is intended to alert the user to the presence of important operating and maintenance instructions in the literature accompanying the appliance.



To reduce the risk of fire or electric shock, do not expose this equipment to rain or moisture.

- TO REDUCE THE RISK OF ELECTRIC SHOCK,
- DO NOT REMOVE COVER (OR BACK).
- NO USER-SERVICEABLE PARTS INSIDE.
- REFER SERVICING TO QUALIFIED SERVICE PERSONNEL.



Use of controls, adjustments or performance of procedures other than those specified herein may result in hazardous radiation exposure.

Important Safety Instructions



This symbol indicates caution points.



This symbol indicates actions that should not be done.



This symbol indicates actions that must be performed.



- Do not place the equipment on any uneven or unstable carts, stands, tables, shelves etc. The equipment may fall, causing serious injury to children or adults and serious damage to the equipment itself.



- Use only a cart or stand recommended by the manufacturer. This equipment and recommended cart or stand should be handled with care. Quick stops, excessive force, and uneven surfaces may cause the equipment and cart/stand to overturn.



- Do not disable the 3-wire grounding type plug. The grounding pin on the 3-prong plug is an important feature. Removing the grounding pin will increase the risk of damaging the equipment.
- If you can not fit the plug into the electrical outlet, contact an electrician to install a grounding outlet.
- Always operate this equipment from the type of power source indicated on the rear of the serial/model plate.
- Never overload wall outlets and extensions.



- Use and handle the power cord with care. Do not place any heavy objects on the AC power cord.
- Do not pull the AC power cord. Do not handle the AC power cord with a wet hand.
- Do not touch the power cord and antenna cable during lightning.
- Remove the plug from the wall outlet, if the equipment will not be used for a long period of time.
- Do not place, use or handle this equipment near water.
- Never expose the equipment to liquid, rain, or moisture.
Seek for service if any of the above is spilled into the equipment.
- Do not expose the equipment to extreme temperature or to direct sunlight, as the equipment may heat up and suffer damage.
- Do not install the equipment near any heat sources such as radiators, heat registers, stoves, or any other apparatus that might produce heat.
- Do not attempt to service the equipment yourself.
- Opening and removing the covers may expose you to dangerous voltage or other hazards and may void your warranty. Refer service to qualified personnel.
- Do not place or drop any other objects on top.
- Do not insert anything into the ventilation holes of your equipment.
Inserting any metal or flammable objects may result to fire or electric shock.
- Protect the power cord from being walked on or pinched particularly at plugs, convenience receptacles, and the point where they exit from the apparatus.
- Do not place the equipment on uneven or unstable carts, stands, tables, shelves etc. The equipment may fall, causing serious injury to children or adults and serious damage to the equipment itself.
Always place the equipment on the floor or on a surface that is sturdy, level, stable and strong enough to support the weight of the equipment.
- Do not block any ventilating openings. Leave an open space around the equipment.
Never place the equipment :
on a bed, sofa, rug, or any other similar surfaces; too close to drapes/curtains/walls, in a bookcase, built-in cabinet, or any other similar places that may cause poor ventilation.
- Unplug this apparatus during lightning storms or when unused for long periods of time.
- Refer all servicing to qualified service personnel. Servicing is required when the apparatus has been damaged in any way, such as power-supply cord or plug is damaged, liquid has been spilled or objects have fallen into the apparatus, the apparatus has been exposed to rain or moisture, does not operate normally, or has been dropped.



- Always remove the power cord from the outlet before cleaning the equipment.
- Never use liquid or aerosol cleaners on the equipment.
Clean only with a soft dry cloth.



- Only use attachments/accessories specified by the manufacturer.

Antenna Safety Instructions

If an outdoor antenna is connected, follow the precautions below:



- An outdoor antenna should not be located in any area where it could come in contact with overhead power lines, or any other electric light or power circuits.
- When installing an outdoor antenna system, extreme caution should be taken to prevent contact with power lines. Direct contact with power lines may be fatal and should be avoided at all costs.

Section 810 of National Electrical Code (NEC) provides information with respect to proper grounding of the mast and supporting structure, grounding of the lead-in wire to an antenna discharge unit, size of grounding conductors, location of antenna discharge unit, connection to grounding electrodes, and requirements for the grounding electrode.

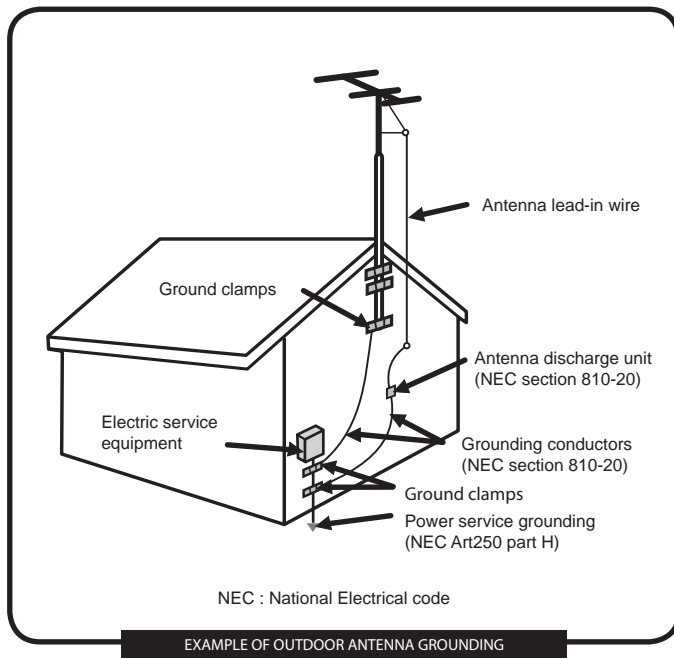

TABLE OF CONTENTS



- Preparation
 - Important Safety Instructions 1
 - Antenna Safety Instructions4

- Chapter 1 Introducing the LCD TV
 - Package Contents.....6
 - Setting Your LCD TV..... 7
 - Your LCD TV.....8
 - Remote Control.....11

- Chapter 2 Installing the LCD TV
 - Connecting a TV Cable or Aerial.....14
 - Connecting a DVD Player17
 - Connecting a VCR & Video Camera.....18
 - Connecting a TV box and satellite Receiver19
 - Connecting an Audio Receiver20

- Chapter 3 Using The Features
 - Basic Operation.....21
 - OSD Menu Operation..... 22
 - The Video Settings.....23
 - The Audio Settings.....23
 - The Setup Settings.....24
 - The Parental Settings..... 25
 - The Screen Settings.....25
 - Using The DVD Features.....26

- Troubleshooting.....35

- Specifications.....37

Package Contents

Make sure all of the following contents are included.

- LCD TV



- Remote Control/
AAA Batteries x 2

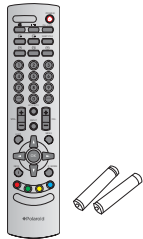

- VIDEO Cable



- Component Cable

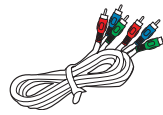

- Power Cord



- AUDIO Cable

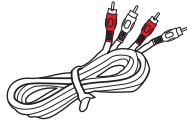

- Warranty Card

- User's Manual

- Quick Start Guide

These items are all you need to set up and operate the LCD TV in its basic configuration.



Make sure all of the above contents are included in the package. If you are missing any items, please contact the Polaroid customer service department.

Setting Up Your LCD TV

How to install the TV Stand

Follow the instructions below to install the TV stand:

- 1 Open the box, and make sure all necessary parts are in the box. The package contains:



- 2 Cover an even stable surface with a soft cloth. Place the LCD TV unit face-down on the cloth. Fit the stand onto the bottom of the LCD TV unit as shown:

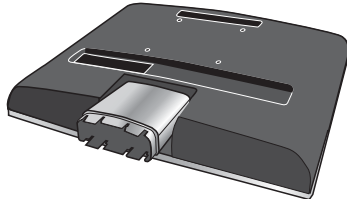

- 3 Then push until the stand clicks into the LCD TV's stand socket.

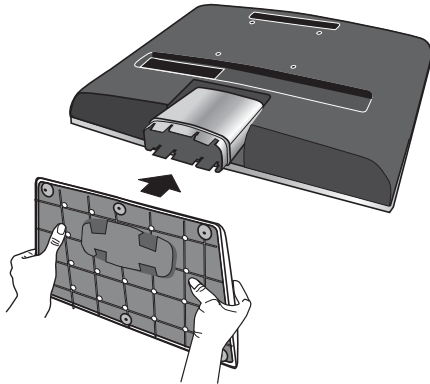

To Remove the LCD TV's stand socket for wall mounting:

Ensure the stand base is removed. For wall mounting the stand socket attached to the back of the TV should be detached. Using a Phillips screwdriver remove the screw which is inside the stand socket. The stand socket section should then slide off the locator rod connected to the TV.

To attach this LCD TV to a wall a standard 100x100 VESA mounting bracket is required.

How to setup the TV

- 1 Use a supplied antenna cable to connect the VHF/UHF signal to the LCD TV's ANT. terminal (refer to page 15-18).
- 2 Connect the AC power cord at the back of the TV and connect the power cord to wall outlet.
- 3 Insert the 2 batteries supplied in remote control.

Step1 Slide the back cover up to open the battery compartment of the remote control.

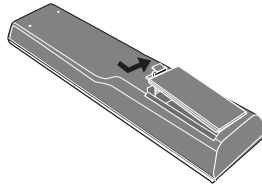

Step2 Insert two AAA size batteries. Make sure to match the (+) and (-) ends of the batteries with the (+) and (-) ends indicated in the battery compartment. Slide the cover back into place.

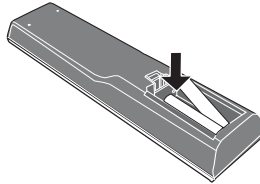

Do not use caustic cleaners (porcelain, stainless steel, toilet, or oven cleaner etc.) on the remote, as it may suffer damage.

- 4 Connect other an external AV device (refer to page 19-25).

Your LCD TV

Front/Left /Right Side View and Controls

ENGLISH

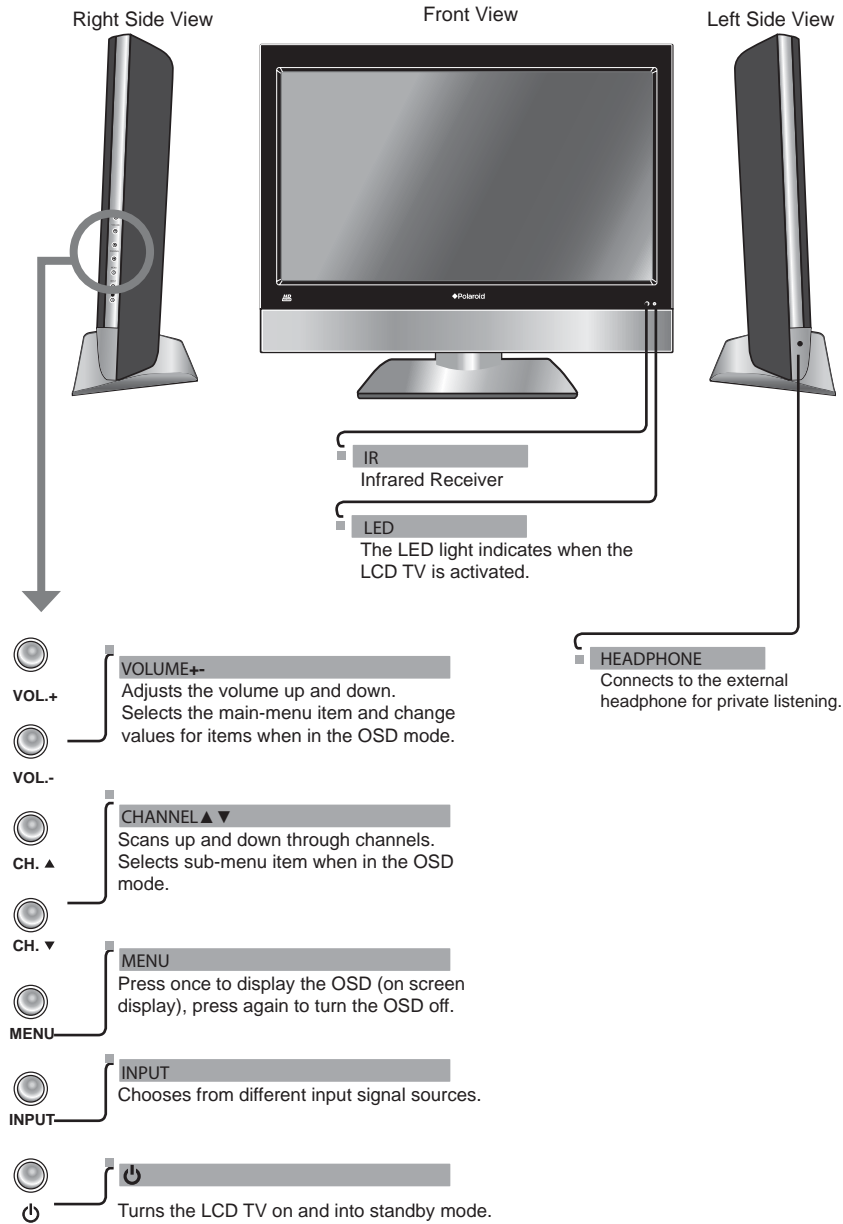

Rear View and Jacks

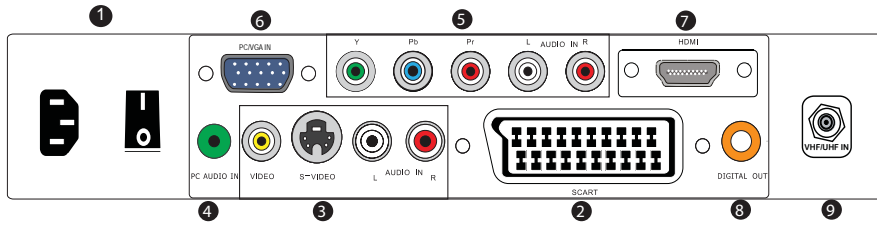

ITEM	DESCRIPTION
1 AC IN / Power Switch	Connects the AC power cord to this socket./ Make sure that this switch is in the ON position (Red LED light will show on the bottom centre of the TV).
2 AV1 SCART	Connect to external equipment with scart socket. This scart input allows audio and CVBS/YC/RGB+CVBS. RGB,S-VIDEO from an external devise to be shown on your TV.
3 AV2 S-VIDEO/AUDIO (L/R)	Connects to the S- VIDEO output sockets and Audio output sockets on your video equipment.
4 AV3 VIDEO/AUDIO(L/R)	Connects to the composite A/V output sockets on your video equipment.
5 AV4 Y, Pb, Pr /AUDIO(L/R)	Connects to the component (Y, Pb, Pr) video sockets and audio (L/R) sockets of your DVD player, HDTV, or video equipment.
6 AV5 PC/VGA IN/PC AUDIO IN	Connects to a PC or other devices with a VGA interface.
7 AV6 HDMI IN	Connects to devices with a HDMI interface.
8 DIGITAL OUT	Connects to digital out socket on external digital audioequipment.
9 VHF/UHF IN	Connects RF input from VHF/UHF antenna or cable to receive high/standard definition television.

Your Remote Control

- 1 **POWER**
Turns the LCD TV on and into standby mode .
- 2 **MUTE**
Mutes and restores your LCD TV sound.
- 3 **ATV/DTV**
Pressing enter ATV (analogue) or Digital (DTV) Mode.
- 4 **0-9**
Select and switch to a channel by using 0-9 buttons.
- 5 **GUIDE**
In DTV mode,pressing GUIDE key displays the electronic program guide on the screen.
- 6 **CH. +/-**
Changes the channels up and down .
- 7 **VOL. +/-**
Increases and decreases volume.
- 8 **SLEEP**
Sets the LCD TV sleep time.
- Press the SLEEP button to select the number of minutes. followed by 15, 30, 60minutes and off. The timer begins to count down from the number of minutes selected.
a.To check the remaining sleep time, press the SLEEP button once.
b.To cancel the sleep time, repeatedly press the SLEEP button until the display off appears.
c. If you turn the set off after setting the sleep timer, the setting will be erased.
- 9 **CH. LIST**
Display all channel list & name.
SUBTITLE
Press the SUBTITLE key to display the subtitle which is broadcast with the program on the screen.
- 10 **Teletext**
Turns on and off the Teletext function.
- 11 **I-II**
Cycles through the TV Sound options: MONO/DUAL/STEREO.

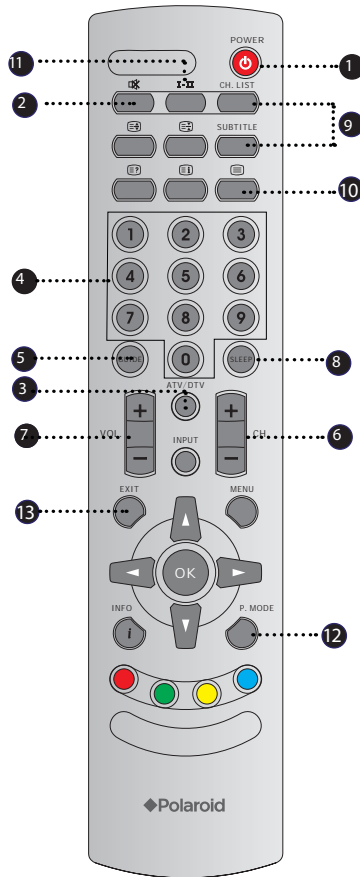

- 12 **P.MODE**
Selects picture mode: Custom, Vivid, Standard, Mild.
- 13 **EXIT**
Exits the OSD menu (on-screen display).

14 MENU

Displays the OSD menu (on screen display).

15 ▲▼◀▶ OK

Allows you to move, select and set up the OSD options.

16 INFO

Pressing once displays a variety of information such as the current channel and the input source.

17 INPUT

Cycles among the different input signal INPUT:

TV AV1(SCART) AV2(S-VIDEO) AV3(CVBS) AV4(Y-Pb Pr) AV5(VGA) AV6(HDMI) DTV →
↑

18 

Displays the main index in Teletext mode.



Reveals hidden information such as the answer to a quiz in Teletext mode.



Freezes a multi-page passage on screen in Teletext mode.



Displays the top, bottom or all of page, to easily read in Teletext mode.

29 ● ● ● ●

Accesses the TELETEXT items or corresponding pages. The coloured buttons are used to access interactive modes when using Digital / Freeview TV channels.

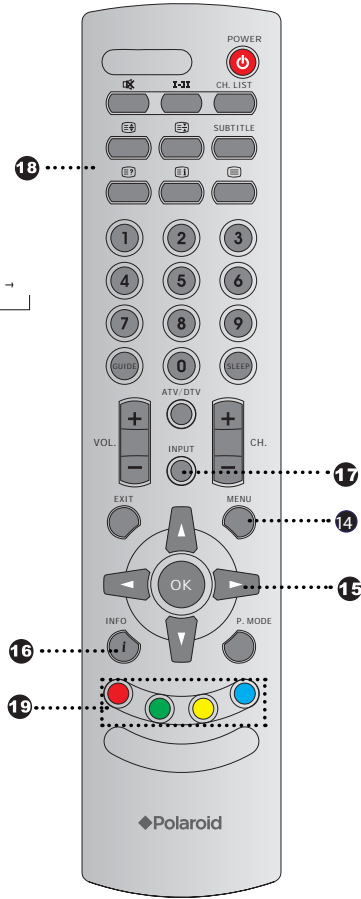

Chapter 2

Installing the LCD TV

Refer to the owner's manual of any external equipment to be connected.
When connecting any external equipment, do not connect any AC power cords to wall outlets until all other connections are completed.

ENGLISH

Connecting a TV Cable or an Antenna

Antenna Connection

The antenna requirements for good color TV reception are more important than those for a black & white TV reception. For this reason, a good quality outdoor antenna is strongly recommended. The following is a brief explanation of the type of connection that is provided with the various antenna systems.

- A 75-ohm system is generally a round cable (not included) with F-type connector that can easily be attached to a terminal without tools.

F-type connector



75-ohm coaxial cable (round)

- A 300-ohm system is a flat twin-lead cable (not included) that can be attached to a 75-ohm terminal through a 300-75-ohm adapter (not included).



300-ohm twin-lead cable (flat)

Use one of the following two diagrams when connecting an outdoor antenna.

A: Shows how to use a VHF/UHF combination outdoor antenna.

B: Shows how to use a separate VHF and/or UHF outdoor antenna.

A. Combination VHF/UHF antenna

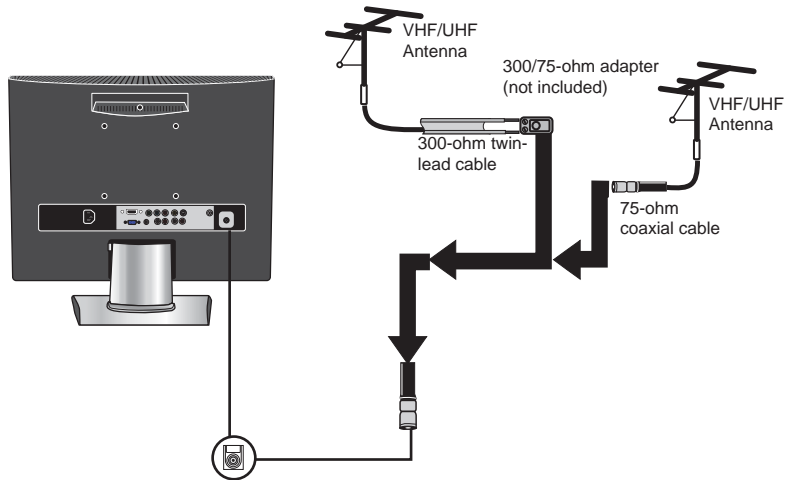

B. Separate VHF and/or UHF antennas

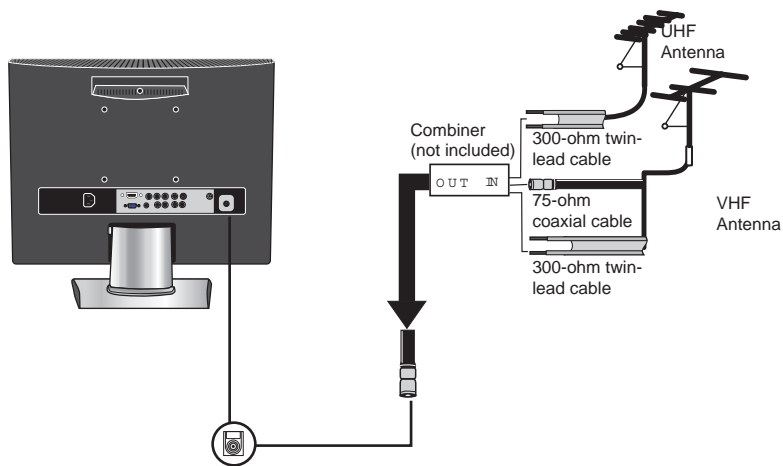

Cable TV (CATV) Connection

ENGLISH

- A 75-ohm coaxial cable connector is built into the set for easy hookup. When connecting the 75-ohm coaxial cable to the set, connect the 75-ohm cable into the ANT. terminal.
- Some cable TV companies offer premium pay channels. Since the signals of these premium pay channels are scrambled, a cable TV converter/descrambler is generally provided to the subscriber by the cable TV company.

This converter/descrambler is necessary for normal viewing of scrambled channels. (Set your TV to channel 3 or 4, typically one of these channels is used. If this is unknown, consult your cable TV company.) For more specific instructions on installing cable TV, consult your cable TV company. One possible method of connecting the converter/descrambler provided by your cable TV company is shown in the diagram below.

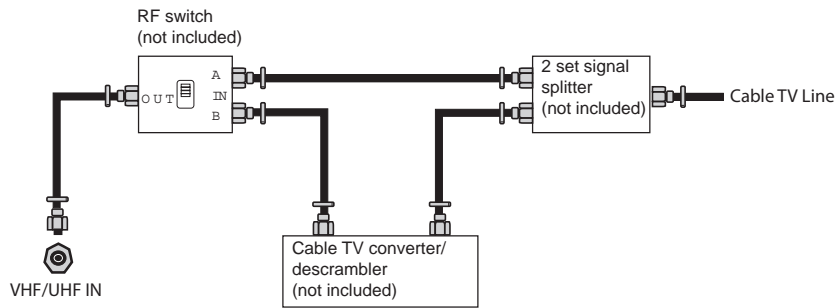

- The RF switch (not included) is required to provide two inputs (A and B). Setting the RF switch to position A allows viewing of all unscrambled channels by using the TV channel keys.
- Setting the RF switch to position B allows viewing of all scrambled channels via the converter/descrambler by using the converter channel keys.

- 1 Use a supplied antenna cable to connect the TV signal to the LCD TV's TV CABLE terminal.

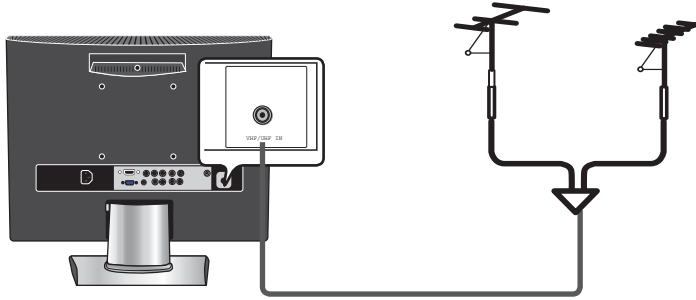

- 2 Connect the AC power cord at the back of the TV and connect the power cord to wall outlet.

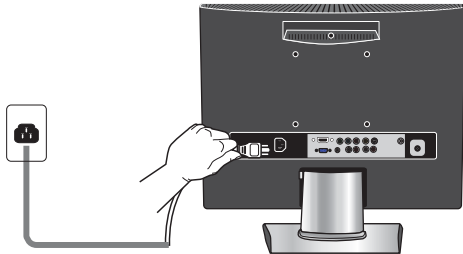

- 3 Press the **POWER** button on your remote to turn on your LCD TV.
- a. After connecting an aerial to your LCD TV and connecting the mains cable to the TV and 230VAC mains socket, turn the **POWER SWITCH** of rear TV on, a red light will show on the front centre panel of the TV.
 - b. Press the **POWER** button, the red light will change to green and the First Time Installation screen will show:
 - 1. Make sure an aerial is fitted then press **OK** button on the remote to start the Auto Programme Scan (APS).
 - 2. In a short while you will see the TV programmes briefly as each channel is received and stored in the memory. When APS is completed BBC1 will show, press **CH+/-** buttons to view the other channels stored.
 - c. To power off press the **POWER** button, the green light will change to red.
- 4 Press the **SOURCE** button and choose TV or DTV mode then press **OK** to select.
-

Connecting a DVD Player

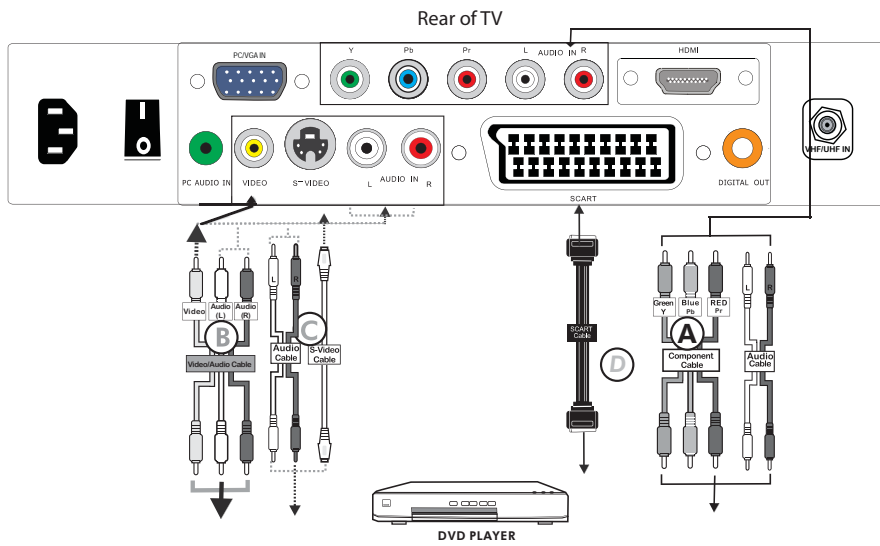

ENGLISH

1**METHOD A (AV4)**

Use a Component cable to connect the (Y Pb Pr) sockets on the DVD player to your LCD TV.
Use an audio cable to connect the DVD's audio sockets to your LCD TV.

METHOD B (AV2)

Use an Audio cable to connect the DVD's audio output sockets to your LCD TV.
Use a S-Video cable to connect your LCD TV and DVD player.

METHOD C (AV3)

Use an A/V cable to connect the DVD's composite output sockets to your LCD TV.

METHOD D (AV1)

Use a SCART cable to connect the DVD's SCART socket to the LCD TV's SCART socket.

2

Connect all power INPUTs before turning on the power switch of the LCD TV or other connected equipments.

3

Press the POWER button to turn on your LCD TV.

4

To watch DVD, press the INPUT button to select AV1,AV2, AV3,AV4.

Connecting a VCR & Video Camera

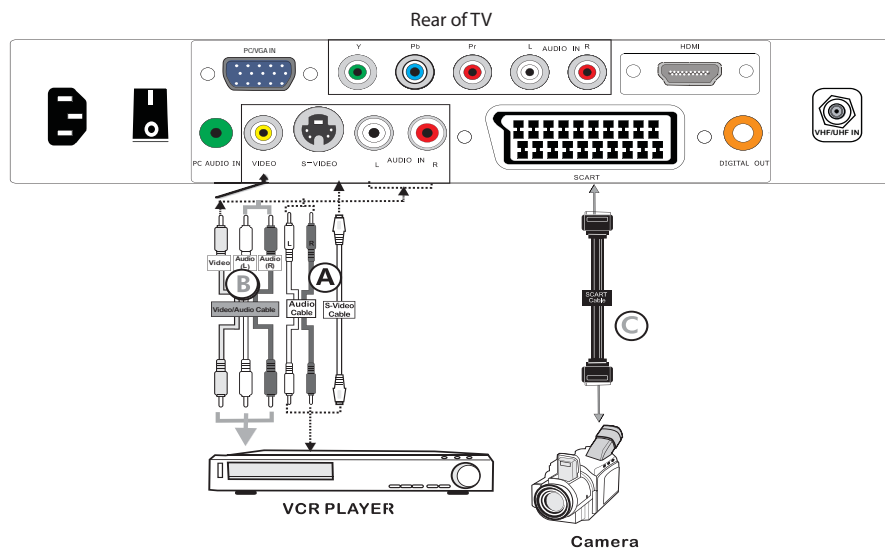

- 1 **METHOD A (AV2)**
Use an Audio cable to connect the VCR's/ the Video Camera's audio output sockets to your LCD TV.
Use a S-Video cable to connect your LCD TV and VCR player/ video camera.

METHOD B (AV3)
Use an A/V cable to connect the VCR's/ video camera's composite output sockets to your LCD TV.

METHOD C (AV1)
Use a SCART cable to connect the VCR's SCART socket to the LCD TV's SCART socket.

- 2 Connect all power INPUTS before turning on the power switch of the LCD TV or other connected equipments.
- 3 Press the POWER button to turn on your LCD TV.
- 4 To watch video camera, press the INPUT button to select AV2 or AV3.
- 5 To watch VCR, press the INPUT button to select AV1, AV2 or AV3.

! "Not all cameras have the ability to connect to a TV. Please check your video camera user guide for compatibility".

Connecting a TV Cable Box or Satellite Receiver

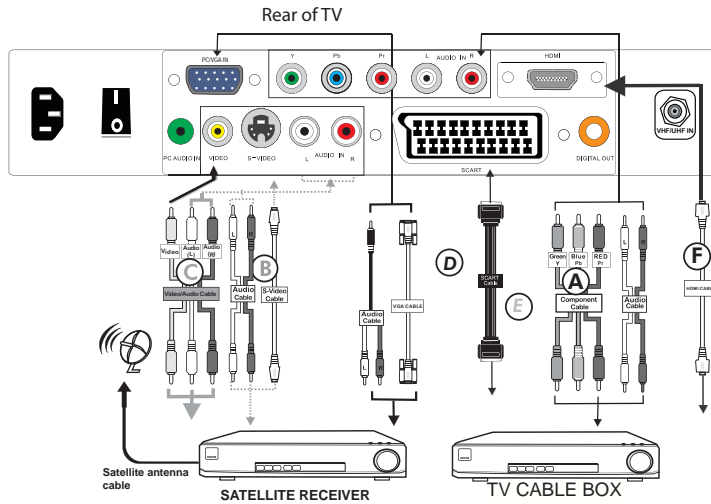

ENGLISH

- 1** Method A(AV4) :
Use a Component cable to connect the Y/Pb/Pr sockets on the TV Cable Box to your LCD TV.
Use an Audio cable to connect TV cable box's audio output sockets to LCD TV.

Method B(AV2) :
Use an Audio cable to connect the TV Cable Box's audio output sockets to your LCD TV.
Use a S-Video cable to connect your LCD TV and TV Cable Box.

Method C(AV3) :
Use an AV cable to connect the TV Cable Box's composite output sockets to your LCD TV.

Method D(AV5) :
Use a VGA 15 pins cable to connect the TV Cable Box's RGB output sockets to your LCD TV.
Use a 3.5mm socket to RCA adapter cable for connecting audio.

Method E(AV1) :
Use a SCART cable to connect the TV Cable Box's SCART socket to the LCD TV's SCART socket.
- 2** Method F(AV6) :
Use a HDMI cable to connect the Satellite Receiver HDMI connector to your LCD TV.
- 3** Connect all power INPUTs before turning on the power switch of the LCD TV or other connected equipments.
- 4** Press the POWER button to turn on your LCD TV.
- 5** To watch TV cable box, press the INPUT button to select AV1, AV2, AV3, AV4, AV5.
- 6** To watch programs satellite receiver, press the INPUT button repeatedly to select AV6.

Connecting an Audio Receiver

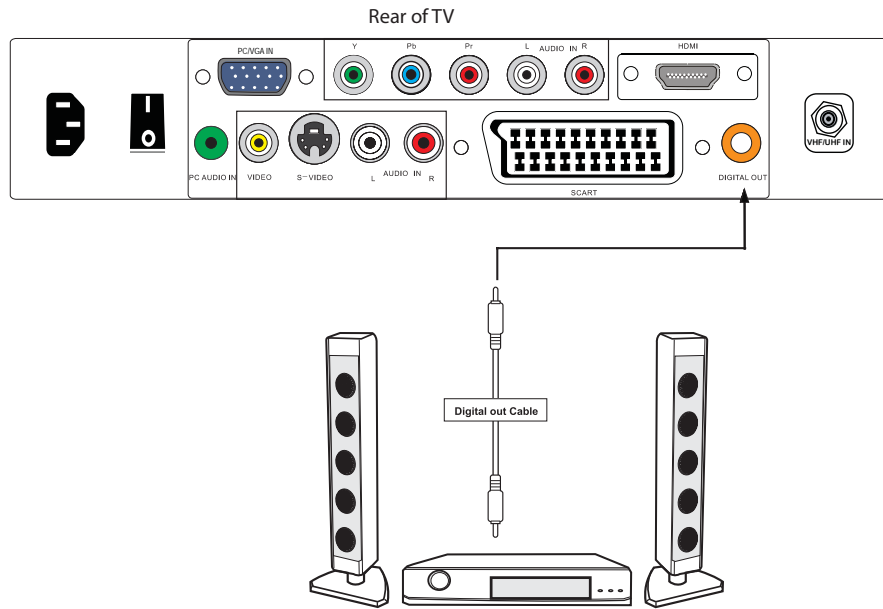

- 1** Use an audio cable to connect the audio receiver's audio LINE IN sockets to LCD TV's DIGITAL OUT sockets.
- 2** Connect all power INPUTs before turning on the power switch of the LCD TV or other connected equipments.
- 3** Press the POWER button to turn on your LCD TV.

Chapter 3

USING THE FEATURES

Tuning in the TV channels

After connecting an aerial to your LCD TV and connecting the mains cable to the TV and 230VAC mains socket, turn the POWER SWITCH of rear TV on, a red light will show on the front centre panel of the TV.

Press the POWER button, the red light will change to green and the First Time Installation screen will show:

1. Make sure an aerial is fitted then press OK button on the remote to start the Auto Programme Scan (APS).

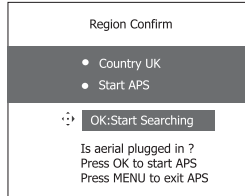

2. In a short while you will see the TV programmes briefly as each channel is received and stored in the memory. When APS is completed BBC1 digital TV will show, press CH+/- buttons to view the other channels stored. When finished ATV scan, TV will Auto change to DTV do the first installation channel. To view analogue TV press INPUT button and use the up / down arrow buttons to select TV and then Press the OK button. Change channels by pressing the CH +/- buttons.

To power off press the POWER button, the green light will change to red.

Selecting a INPUT

Press the INPUT button to display the function required (TV/AV). Using the arrow buttons on the remote highlight the function required and press the OK button to select the function.

Select TV Channel

Press the CH.+/- button on the remote control and the CH.+/- button on the LCD TV to change the TV channels.

You can directly select the TV channel required by pressing 1, 2 or 3 etc on the remote button pad.

Adjusting the Volume

Press the VOL. +/- button on the remote control or the VOL. +/- button on the LCD TV to adjust the volume.

To Mute the Sound

Press MUTE and the sound cuts off.

To turn mute off, press the MUTE button again, or simply press the VOL +/- button.

Sleep Timer

Press the SLEEP button continuously to select the sleep timer or turn the sleep timer from the OFF, 15, 30, 60 minutes; when the LCD TV has reached the set time, it will automatically turn off. If the TV has no input signal, it will automatically power down to standby after 15 minutes.

OSD Menu Operation

1 The main menu provides access to the following menus:

Video	Adjust picture setting such as picture mode, contrast, brightness, sharpness colour and advanced.
Audio	Adjust sound option and effects.
Setup	Adjust colour standard, sound standard, APS, Manual search, Channel setup.
Preferences	Adjust preferences such as OSD, blue screen, childlock, sleep timer, OSD timer, OSD reset.
Screen	Adjust screen such as horizontal size, horizontal position, vertical position, phase, auto sync.
DTV (Digital TV)	The DTV menu provide four submenus as follow: edit channel list, configuration, parental control, EPG (Electronic Programme Guide), with which you can set the DTV as you wish.

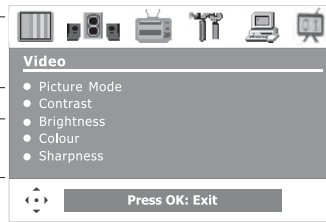

2 Press the MENU button on the remote control. The main menu will appear on the screen.

3 Use ◀/▶ to highlight your main menu option, then press OK to enter your selected option.

Use ▲/▼ to highlight an option of the sub-menu. Use ◀/▶ to change the value of the item. Press the EXIT button to exit menu.

VIDEO

Use this Video setting menu to adjust the picture quality which best corresponds to your viewing requirements. The Video Menu includes the following options:

OPTION	DESCRIPTION
Picture Mode	Custom: Select for user's settings. The items of video can be adjusted when the picture mode is for user's settings except advanced item.
	Vivid: Select for enhanced picture contrast and sharpness.
	Standard: Select for standard picture settings. Recommended for home entertainment.
	Mild: Select for mild picture settings.
Contrast	Adjust the difference between the brightness and darkness regions of the picture.
Brightness	Adjust to increase or decrease the brightness.
Colour	Allows to adjust the colour from 0 to 100.
Tint(NTSC)	Allows you to adjust the color tint of the picture. (Only for NTSC)
Sharpness	Adjust to sharpen or soften the picture.

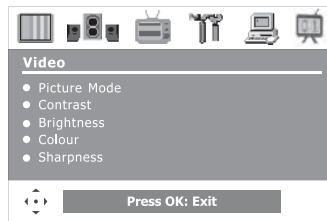

The VIDEO Settings

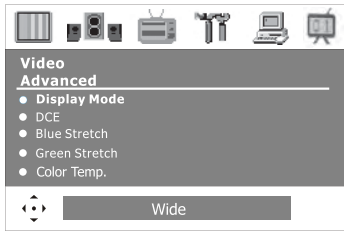

OPTION	DESCRIPTION
Advanced	
Display Mode	Allows you to select the display mode to be Wide, 4:3,Original, Zoom.
DCE	Allows you to adjust the (Dynamic Contrast Enhancemen) to be off, low, mid, high.
Blue Stretch	Allows you to adjust the blue stretch.
Green Stretch	Allows you to adjust the green stretch.
Color Temp.	Allows you to adjust the color temp. to be cool, warm , standard.

ENGLISH

AUDIO

Use this AUDIO setting menu to adjust the sound and balance and volume to your listening requirements.

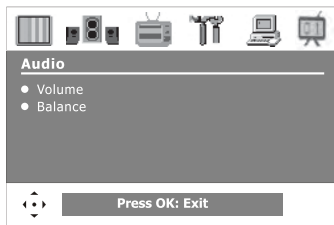

OPTION	DESCRIPTION
Volume	presets the volume to a given setting.
Balance	Adjust to emphasize left or right speaker balance.

The Setup Settings(Analogue TV)

Setup menu is only available when viewing Analogue TV. Use this Setup menu to select Colour Standard, Sound Standard, APS, Manual Search, Channel Setup. Use the Up/Down arrow buttons to highlight the required setting. Press the Press OK button to select the function. Use left / right arrow buttons to adjust the settings. Press OK to save the adjustment.

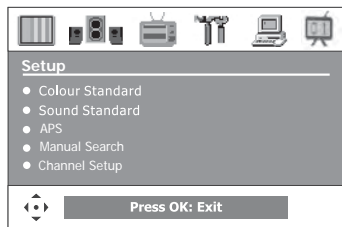

OPTION	DESCRIPTION
Colour Standard	Allows you to select the colour standard : AUTO,PAL, SECAM, UK = PAL.
Sound Standard	Allows you to select the sound standard : DK, BG, I, L/L'
DK	PAL D/K, SECAM D/K (East Europe / China)
BG	PAL B/G, SECAM B/G (Europe / East Europe / Asia / New Zealand / M.East / Africa /Australia)
I	PAL I (U.K. / Ireland / Hong Kong / South Africa)
L/L'	SECAM L/L'

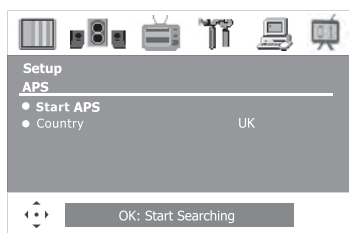

APS	Start APS Press OK to start Auto Search and auto sort process. Note: Auto Sort will only operate in UK. Country Allows you select the country :Austria, Belgium, Switzerland, Czech Rep., Germany, Denmark, Spain, France, Finland, UK, Greece, Hungary, Italy, Norway, Netherlands, Portugal, Poland, Sweden, Slovenia, Slovakia, Turkey, Others.
-----	---

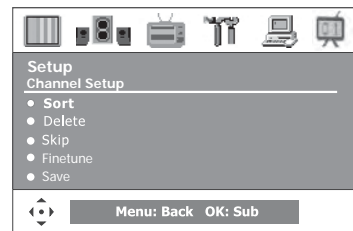

Channel Setup	Press the ► button to select Sort, Delete, Skip, Finetune, Save.
Sort	Allows you to manually sort the stored programme.
Delete	Allows you to delete the stored programme.
Skip	Allows you to skip the stored programme.
Finetune	Allows you to finetune the stored programme.
Save	Allows you to save the set-up.

The Preferences Settings

Use this Preferences setting menu to set up some features: OSD, Blue Screen, Childlock, Sleep Timer, OSD Timer, OSD Reset.

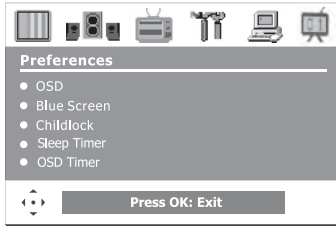

OPTION	DESCRIPTION
OSD	Language : Allows you to select the OSD to be English, French, Spanish, German, Italian, Portugese, Dutch, Polish . Transparency: Allows you to adjust transparency from 0 to15.
Blue Screen	Allows you to select the blue screen to be off or on.
Childlock	Allows you to select the childlock to be yes or no. (Default password is 0000. golden password is 3796.) Change Pin: Allows you to change the 4-digit password.
Sleep Timer	Allows you to select the sleep timer to be off, 15min, 30min, 60min.
OSD Timer	Allows selection of the display time of the on-screen menu:5 s,10 s,15 s, 20 s, 25 s.
OSD Reset	Allows you to restore the factory settings.

ENGLISH

SCREEN(Only for VGA)

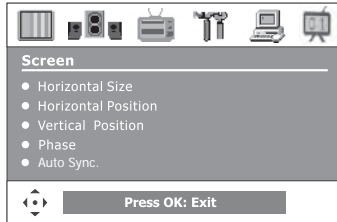

OPTION	DESCRIPTION
Horizontal Size	Allows you to adjust the Horizontal Size from 0 to 100.
Horizontal Position	Allows you to adjust the Horizontal Position of the picture.
Vertical Position	Allows you to adjust the Vertical Position of the picture.
Phase	Allows you to improve focus clarity and image stability.
Auto Sync.	Allows to auto synchronize VGA signal.

Chapter 4 Using the DTV OSD Settings

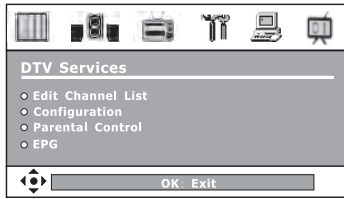

OPTION	DESCRIPTION
Edit Channel List	Lock some channels that are not suited for younger members of the family, skip/add the channel list as you wish.
Configuration	Add new channel, set audio language, subtitle language, as you wish. Upgrade the system. View the signal information.
Parental Control	Enable or Disable the menu protection system and allows the PIN code to be changed.
EPG	Electronic Program Guide

EDIT CHANNEL LIST

Highlight the Edit Channel List option, then press OK button, there are three items in the menu.



CREATE A FAVOURITE LIST

Highlight the Create a favourite list item, pressing OK button, then The menu is displayed on the screen now. Once you enter the Create a favourite list menu, a new channel list will be created, you can create four favourite lists at most.

You can lock or unlock the selected channel by pressing the RED button, pressing the BLUE button to skip or add the selected channel. If you want to skip or add all, first press the GREEN button, then press either the RED button to skip all, or the GREEN button to add all. A channel selected as a locked appears in the channel list with a lock icon (red button) against the channel name, a channel selected as a added appears in the channel list with a add icon (tick) against the channel name.

Using the DTV OSD Settings

ENGLISH



By pressing the YELLOW button you can sort the channels in the list. Then you can sort the channels alphabetically by pressing the RED button or sort the channels manually by pressing the BLUE button. If you have locked several channels, by pressing the YELLOW button, the locked channels will be placed at the bottom of the Channel list in alphabetical sort.

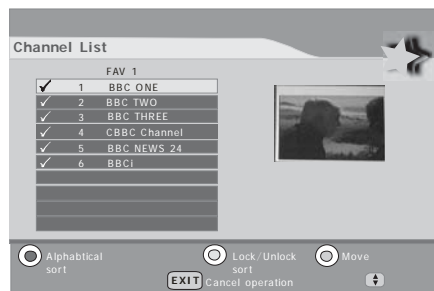

When you complete the edit, press the EXIT button to quit the favourite channel list menu. The next menu will ask if you want to save the changes you have made, using the ◀/▶ buttons to highlight the YES option, and press the OK button to save the changes.

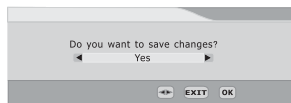

Once you lock a channel, you must enter the PIN Code that is set in the parental control menu at first before the channel is displayed.



If you skip a channel, it cannot be shown in the list menu (Press OK button will pop-up the favorite channel list menu when you watch the digital terrestrial television) unless you add it again. (In the channel list menu, the skipped channel name is not shown.)



MODIFY A FAVOURITE LIST

You can modify the favourite list which you have create. The list named "TV / RADIO" is the default list, the rest are created. Select a favourite list, then press OK button to modify the list as you do in the create a favourite list menu.



DELETE A FAVOURITE LIST

Using the ▲/▼ buttons to highlight the list name which you want to delete, then pressing the OK button to delete the favourite list, the pop-up menu will ask if you confirm or cancel the delete operation.

(Note: The default favourite channel list name isn't displayed in the list, so you can only delete the list name you created.)



Using the DTV OSD Settings

CONFIGURATION

Highlight the Configuration option, then press OK button to enter the selected option. The configuration menu is displayed on the screen now.

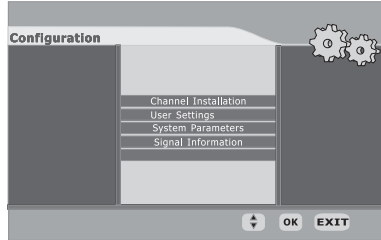

CHANNEL INSTALLATION

Use these options if you have moved location or want to rescan for new channels. Press OK button to display the channel installation menu.

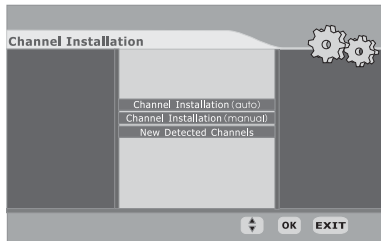

If you want TV to auto search the channels, press OK button to continue. Then you should choose the installation type by using the ◀/▶ buttons and press the OK button to start the installation process. If you choose 'add', the new channels will be added in the channel list. If you choose 'new', the new channels will replace the previous channels in the channel list.

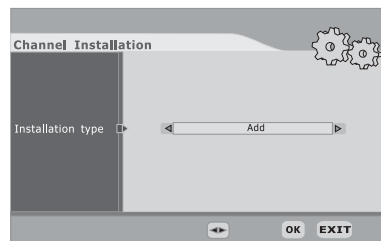

Using the DTV OSD Settings

If you want to install the channels by yourself, using the ▲/▼ buttons to highlight the channel installation (manual) option, and press ok to install manually. First you should choose the installation type, then you can see the following menu. Using ◀/▶ to cycle the channel option, then the bar graphs of signal level and signal quality will indicate whether any channels are likely to be found. You should choose the channel of which the signal quality bar is high as well, then press OK button to scan the channels.

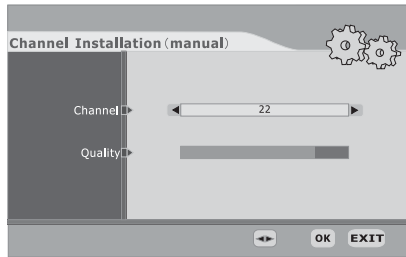

NEW DETECTED CHANNELS

The New Detected Channels menu shows the channels that you add in the channel list recently. The type icon of the program is displayed against the channel name.

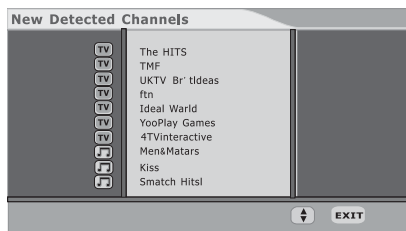

Using the DTV OSD Settings

Using the ▲/▼ buttons to highlight the user settings item in the configuration menu, then press OK button to display the user settings menu.



AUDIO LANGUAGE

This function select which language soundtrack you will hear when switching to a channel broadcasting with multiple soundtracks. Highlight the audio language line in the user settings menu and use ◀/▶ buttons to cycle through the language options.

SUBTITLE LANGUAGE

This function selects the desired subtitle language whenever subtitle information is broadcast. Highlight the subtitle language line in the user settings menu and use ◀/▶ buttons to cycle through the language option.

SYSTEM PARAMETERS

Using the ▲/▼ buttons to highlight the system parameters item in the configuration menu, then press OK button to display the system parameters menu.

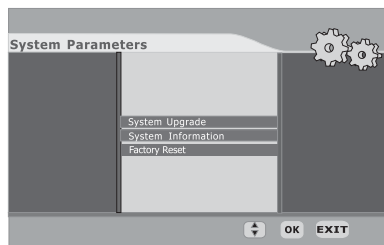

SYSTEM UPGRADE

Highlight the System Upgrade item in the system parameter menu, pressing OK button to display the System Upgrade menu. press OK button to upgrade system. If there is a new software, the unit will upgrade itself.

Using the DTV OSD Settings

SYSTEM INFORMATION

Highlight the system information item in the system parameter menu, pressing OK button to display the system information menu. You can view the system information in this menu, however, you can modify nothing in this menu, Pressing OK button to quit.

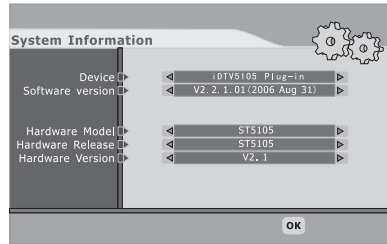

SIGNAL INFORMATION

Highlight the Signal information item in the configuration menu, pressing OK button to display the Signal information menu. Cycle through the channel option by using the ◀/▶ buttons on the remote control. The signal level and signal quality of the channel that offers the upgrade software can be observed on the two bar graphs. The bar graphs of signal quality and signal level give a good indication of whether the selected channel is likely to be found. If the signal quality bar is high as well then it is a digital frequency and digital channels will probably be found.

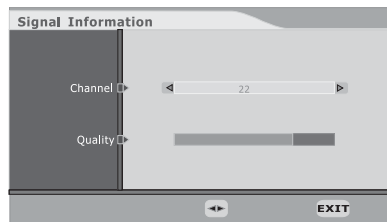

Using the DTV OSD Settings

PARENTAL CONTROL

Highlight the parental control line in the parental control menu and use ◀▶ buttons to cycle through the enable and disable option. Toggle this option to enable, then the following items can be altered.

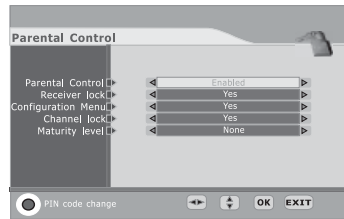

RECEIVER LOCK

You should enter the PIN CODE before you can see the DTV program while you power on the TV and select the DTV INPUT.



CONFIGURATION MENU

If you toggle this option to YES, you must enter the PIN CODE before you can access the configuration menu.

CHANNEL LOCK

If you toggle this option to YES, the channels you locked in the edit channel list menu can't be displayed before you enter the PIN CODE.

MATURITY LEVEL

There are 18 levels total. If you toggle this option to a number (1-18), for example, you toggle it to 15, that's to say, if the channels broadcast material is not suitable for the family members who are under 15 years old, you must enter the PIN CODE before you can view them. (The maturity level information should be broadcast with these programs.)

Using the DTV OSD Settings

PIN CODE CHANGE

Pressing the 'RED' button will popup the PIN code change menu, enter the previous code by using the 0-9 buttons on the remote control, then enter the new code twice to confirm and this menu will disappear (The PIN is factory set to 0000). Pressing EXIT to quit without saving the new code.



Press the OK button to quit the parental control menu and save these alterations. Press the EXIT button to exit the parental control menu without saving these alteration.

EPG

EPG (Electronic Programme Guide) menu is reached by pressing GUIDE button, quit by pressing GUIDE button again. Current program is highlighted. Use Channel Up/Down ▲/▼ buttons to change channels and view the other programmes on the selected channel. Press the Arrow up / Arrow down navigation buttons to scroll through and show programme content. There is a 7day EPG, you can see the other days channel list by using Left / right navigation arrow ◀/▶ buttons.

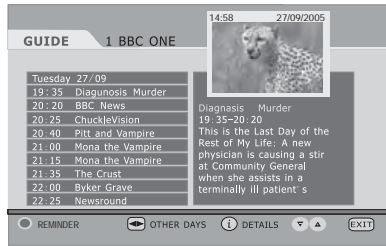

The short description of the highlighted channel is shown under the image window, and you can see the extended description by pressing the INFO or OK button and by pressing this button again you can close this window. Press "RED" button you can reminder the program what you like it, and by pressing this button again you can cancel this reminder.

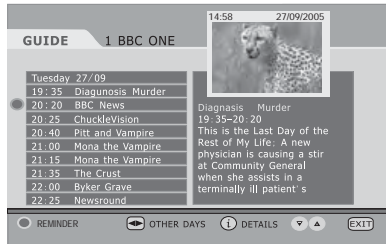

Troubleshooting



Before consulting service personnel, check the following chart for a possible cause of problem and for a possible solution.

TV will not turn on

- 1 Make sure the power cord is plugged in
- 2 The batteries in the remote control may be exhausted.
- 3 Replace new and same brand batteries.

No picture, no sound

- 1 Check the interface cable between TV and antenna/cable TV.
- 2 Press the POWER button on the remote.
- 3 Press the TV button on the remote, then press INPUT button repeatedly to select the connected video INPUTs.

Poor picture, sound OK

- 1 Check the interface cable between TV and antenna/cable TV.
- 2 Try another channel, the station may have broadcast difficulties.
- 3 Adjust the Brightness/Contrast options in the VIDEO Menu.

Picture OK, poor sound

- 1 Sound may be muted. Press the  button on the remote.
- 2 Press the VOL+ button to increase the volume.

Audio noise

- 1 Move any infrared equipment away from the TV.

Key Features

Various Audio/Video terminals for external equipment connection

- 1 set of composite A/V input terminals
- 1 SCART input terminals
- 1 set of component Video input terminals
- 1 VGA/ Audio input terminal
- 1 HDMI/Auido input terminals
- 1 Headphone terminal

High Definition Multimedia Interface (HDMI)

- High Definition Multimedia Interface (HDMI) is a small, user-friendly interconnect that can carry up to 5 Gbps of combined video and audio in a single cable. This system eliminates the cost, complexity and confusion of multiple cables used to connect current A/V systems.

HDTV Component Video Inputs

- Offers the best video quality for DVD(480p) and digital set-top-box (HD1080i, 720p) connections.

3D Digital Noise Reduction

- This function can digitally reduce image noise to provide better picture quality.

WSS(Wide Screen Scale) Function

- This function can automatically convert and display any aspect ration (4:3 / Wide) TV broadcast signal.

Built-in ATV and DTV Tuners

- The built-in DTV tuner allows the reception of DVB-T broadcasting without the addition of a set-top box.

DISPLAY MODES

The screen resolution has been optimized during production for the display modes listed below.

If the signal from the system equals the standard signal mode, the screen adjusts automatically. If the signal from the system is not equal to the standard signal mode, adjust the screen resolution by referring to your video card user guide, otherwise there may be no video.

Video signal: (VGA Standard)

Resolution (Dot X Line)	Vertical Frequency(Hz)	Horizontal Frequency(kHz)
640 x 480	59.94	31.46
	72.80	37.86
	75.00	37.50
800 x 600	60.31	37.87
	72.18	48.07
	75.00	46.87
1024 x 768	60.00	48.36
	70.06	56.47
	75.02	60.02

SPECIFICATIONS

ENGLISH

MODEL		TLU-01541C	TLU-01941C	
LCD Panel	Panel Size	15.4" TFT LCD	19" TFT LCD	
	Brightness	200	300	
	Contrast Ratio	400:1	850:1	
Max. Resolution		1280x800	1440x900	
Input Connector	VIDEO	1	1	
	S-VIDEO	1	1	
	YPbPr/ AUDIO IN(L/R)	1	1	
	AUDIO IN(L/R)	1	1	
	PC/VGA IN	1	1	
	HDMI IN	1	1	
	PC AUDIO IN	1	1	
	DIGITAL OUT	1	1	
	HEADPHONE	1	1	
	VHF/UHF IN	1	1	
	Power Source		AC100~240V, 50/60HZ, 1.2A	AC100~240V, 50/60HZ, 1.2A
	Power Consumption		50 W, standby < 3 W	65 W, standby < 3 W
Dimension		15.2 w x 13.6 h x 5.2 d inch	18 w x 15.9 h x 5.2 d inch	
WEIGHT		7.1 LB	12.3 LB	

20070418